

Millikan Apparatus Power Supply

The Millikan apparatus with power supply is used, depending on the selected measuring method, in conjunction with one or two large electric stop-clocks, to verify the quantization of the electrical charge and to determine the elementary electronic charge.

Bibliography:

„Physic Experiments”, Volume 2 (599 932), Experiment 3.7.2-2/3;
„New Physical Leaflets for Colleges and Universities”, Volume 1 (599 952), Experiment 3.7.2-2/3.

1 Technical Data

1.1 Millikan apparatus (559 41)

Millikan chamber:	8 cm diameter
Distance of capacitor plate:	0.6 cm
Microscope with micrometer eyepiece	
Objective magnification:	1.875-fold
Eyepiece magnification:	10-fold
Illumination device with incandescent lamp:	6 V, 2.5 A; E 10-1802-3 model: MAZDA CYL. PLAT
Dimensions:	32 cm x 37 cm x 32 cm
Weight:	4.7 kg
Connecting cable with multiple plug for illumination device:	approx. 40 cm length

1.2 Power supply (559 42)

Voltage tapping	
for plate capacitor:	0 ... 600 V continuously variable
for illumination device:	6 V; 2.5 A
Moving-coil instrument to measure the capacitor voltage:	
Range:	600 V d. c.
Quality class:	2.5
Scale graduation:	10 V
Scale length:	approx. 8.6 cm
Mains supply:	110/130/220/240 V 50/60 Hz
Fine-wire fuse:	at 220/240 V: M 0.315 B (Spare Part No. 69 810) at 110/130 V: M 0.63 B (Spare Part No. 69 813)
Housing dimensions:	19 cm x 11.5 cm x 16 cm
Weight:	1.5 kg

2 Description

2.1 Millikan apparatus (Fig. 1)

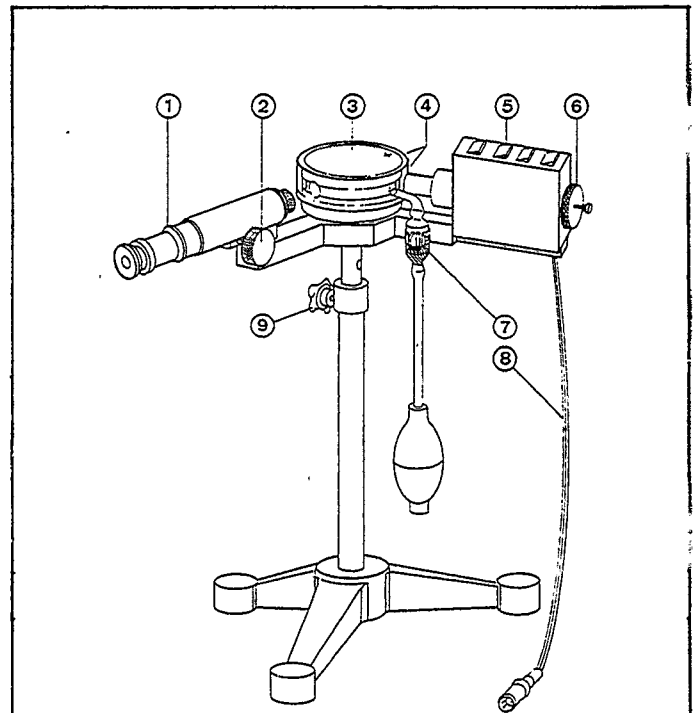
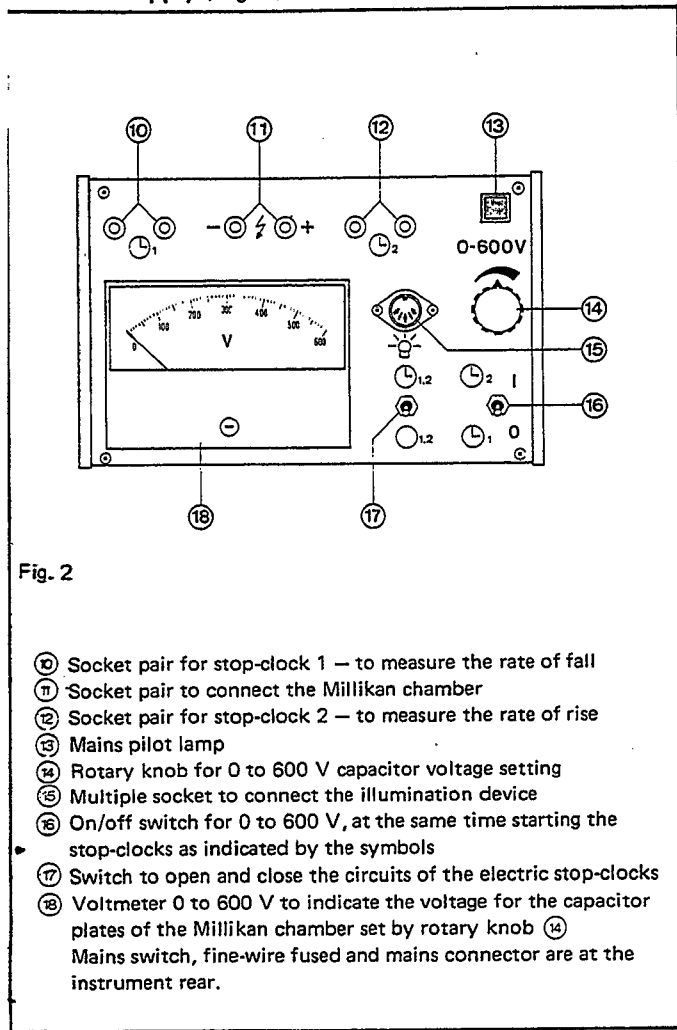

Fig. 1

- ① Measuring microscope with micrometer eyepiece
- ② Knurled knob for microscope adjustment
- ③ Millikan chamber (plate capacitor) with acrylic glass cover
- ④ Socket pair to connect the d. c. voltage for the plate capacitor (can be tapped from socket pair ⑪, adjustable via knob ⑭)
- ⑤ Illumination device
- ⑥ Knurled knob for lamp adjustment
- ⑦ Oil atomizer with rubber ball in resilient holder (one bottle with oil included in scope of delivery)
- ⑧ Connecting cable for lamp voltage (from multiple socket ⑮)
- ⑨ Screw for height adjustment (to adapt the microscope to the eye level of the experimenter)

2.2 Power supply (Fig. 2)



3 Mode of Operation

This method first described in 1913 by R. A. Millikan*) is based on the fact that different indirectly measurable forces act on an electrically charged oil drop moving in the homogeneous electric field of a plate capacitor.

When bringing an electrically charged oil droplet with mass m_{oil} and charge Q into the homogeneous field of a plate capacitor with the electric intensity E , the following forces act on this droplet:

gravitational force $m_{oil} \cdot g$

buoyant force $m_L \cdot g$

(m_L = mass of the air displaced by the oil drop)

electric charge QE

only if the droplet, considered in this case as a sphere, moves as against the ambient air: Stoke's resisting force $6 \pi r \eta v$.

(η = viscosity of the fluid, r = radius of the droplet, v = relative velocity of sphere and fluid).

When taking into account the buoyant force, one writes for $m_{oil} - m_L = m$ and for $\rho_{oil} - \rho_L = \rho$, where ρ_{oil} is the density of the oil, ρ_L the density of the air, m and ρ the corres-

ponding quantities reduced by the buoyancy effect, then, provided that a downward force is to be considered as positive, for a droplet falling through a field-free space with a velocity v_1 the following rule of forces applies:

$$\begin{aligned} mg - 6 \pi r v_1 \eta &= 0 \\ V \rho g - 6 \pi r v_1 \eta &= 0 \\ 4/3 \pi r^3 \rho g - 6 \pi r v_1 \eta &= 0 \end{aligned}$$

$$r = \sqrt{\frac{9 \eta v_1}{2 \rho g}} \quad (I)$$

With U = voltage between the plates of the Millikan chamber, d = plate spacing and v_2 = rise velocity of a droplet, for a droplet moving upward under the influence of an electric field of field strength $E = \frac{U}{d}$ the following relation applies:

$$\begin{aligned} mg - QE + 6 \pi r v_2 \eta &= 0 \\ 4/3 \pi r^3 \rho g - Q \frac{U}{d} + 6 \pi r v_2 \eta &= 0 \end{aligned} \quad (II)$$

For a droplet floating in the chamber under the influence of an electric field it applies accordingly:

$$\begin{aligned} mg - QE &= 0 \\ 4/3 \pi r^3 \rho g - Q \frac{U}{d} &= 0 \end{aligned} \quad (III)$$

This apparatus permits to determine the elementary electronic charge according to two different methods:

3.1 By measuring the voltage at which a charged oil droplet is floating in the Millikan chamber and by measuring the velocity of the droplet falling in the field-free space upon switching off the voltage.

3.2 By measuring the fall velocity of a droplet in the field-free space and the rise velocity of a droplet at a definite voltage to be measured.

The further relationships required for the two methods can be derived from equations (I) to (III) as follows:

Ad 3.1 Determining the elementary electronic charge by measuring the float potential U and the fall velocity v_1 of an oil droplet in the field-free space.

When putting (I) into (III) we obtain

$$Q = \frac{6 \pi d \eta v_1}{U} \sqrt{\frac{9 \eta v_1}{2 \rho g}}$$

Now, the following values are substituted for η , d and ρ :

$$\eta = 1.81 \cdot 10^{-5} \frac{\text{Ns}}{\text{m}^2}$$

$$d = 6 \cdot 10^{-3} \text{ m}$$

$$\rho_{oil} = 875.3 \frac{\text{kg}}{\text{m}^3}$$

$$\rho_L = 1.29 \frac{\text{kg}}{\text{m}^3}$$

$$\rho = 874 \frac{\text{kg}}{\text{m}^3}$$

resulting in the following final equation:

$$Q = 2 \cdot 10^{-10} \frac{v_1^{3/2}}{U} \text{ As} \quad (IV)$$

*) R. A. Millikan: ON THE ELEMENTARY ELECTRICAL CHARGE AND THE AVOGADRO CONSTANT. PHYSICAL REVIEW No. 2, 1913, page 109 ff

Ad 3.2 Determining the elementary electronic charge by measuring the fall velocity v_1 in the field-free space, the rise velocity v_2 in the electric field and the voltage U at the Millikan chamber.

For this equations (I) and (II) are used:

$$Q \frac{U}{d} = 6 \pi \eta v_2 \sqrt{\frac{9 \eta v_1}{2 \rho g}} + 4/3 \pi \rho g \frac{9 \eta v_1}{2 \rho g} \sqrt{\frac{9 \eta v_1}{2 \rho g}}$$

$$Q = (v_1 + v_2) \frac{\sqrt{v_1}}{U} \eta^{3/2} \frac{18 \pi d}{\sqrt{2 \rho g}}$$

When substituting the values for η , d and ρ indicated already under 3.1, one obtains the following final equation which enables relatively quick calculation of the charge values:

$$Q = (v_1 + v_2) \frac{\sqrt{v_1}}{U} \cdot 2 \cdot 10^{-10} \text{ As} \quad (\text{V})$$

4 Operation

4.1 Assembly of the Millikan apparatus (only required prior to initial operation)

Tightly screw together tripod, stand rod and top with Millikan chamber, illumination device and measuring microscope according to Fig. 1. Make sure that the loosely attached Millikan chamber with acrylic glass cover does not fall down when tilting the top.

4.2 Oil filling

Fill the oil atomizer, using the oil (Spare Part No. 68 578) supplied with the apparatus through the spray nozzle so that the bent capillary tube stands by about 2 mm in the oil. Fit the oil atomizer into the resilient holder making sure that the spray nozzle is positioned before the two boreholes in the acrylic glass cover of the Millikan chamber.

4.3 Notes on time measurement

Depending on the method employed, connect 1 time measuring instrument (e. g. 313 04 or 313 03 or 575 45) to socket pair ⑩ or 2 time measuring instruments to socket pairs ⑩ and ⑫ (see Fig. 3.1 to 3.3); other circuits are shown in section 7, Figs. 6.1 — 6.3.

When using the large electric stop-clock (313 04) please note:

Turn switch (a) downward when the circuit diagram on the large electric stop-clock (313 04) corresponds to detail drawing 1 (Fig. 3.1).

Turn switch (a) upward when the circuit diagram corresponds to detail drawing 2.

For description of measuring methods using electric stop-clocks: see Description of Experiment, Section 7.

Instead of the electric stop-clocks optionally also one or two manual stop-clocks (313 07) can be used. In such a case do not operate switch ⑰. Its position is arbitrary. Start or stop the clock simultaneously with reversing the switch. Particularly for the measuring methods described in Section 3.2 now two persons are required to carry out the measurements.

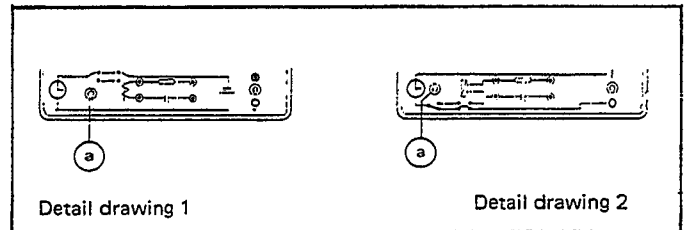
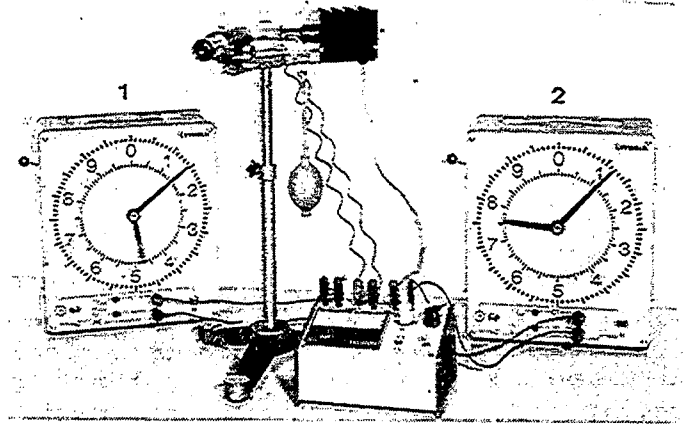

Fig. 3.1

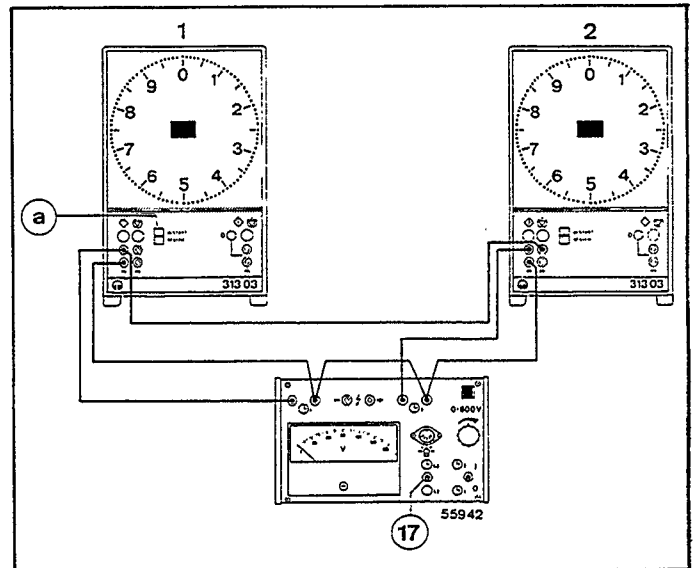

Fig. 3.2

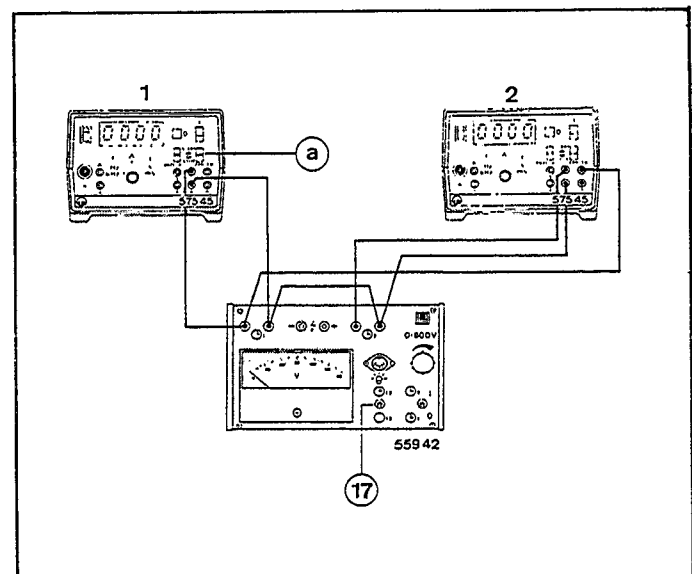

Fig. 3.3

4.4 Determining the distance s travelled by an oil droplet; experimental magnification of the microscope objective

When an oil droplet moves along a distance s' of x micrometer scale divisions ($= x \cdot 10^{-4}$ m), the actual distance travelled s , taking into account the 1.875-fold objective magnification, is

$$s = \frac{x}{1.875} \cdot 10^{-4} \text{ m}$$

The microscope magnification may differ from the above mentioned value for different apparatus. The difference will, however, not significantly exceed $\pm 1\%$.

Using the glass rule with mm division (311 09) you can determine the microscope magnification yourself: Remove the Millikan chamber with acrylic glass cover from the top of the stand rod. Place the glass rule with mm graduation, using flat eraser or similar, vertically against the now visible centering rod. Adjust microscope by means of knurled screw, so that the mm graduation of the glass rod is sharply visible. The magnification can be calculated by comparing the micrometer scale in the eyepiece (0.1 mm spacing between divisions) with the mm graduation of the glass rod. Subsequently place the Millikan chamber with acrylic glass cover again in position.

4.5 Description of Experiment

The quantization of the electric charge can already be verified by approx. 6 to 8 measurements, whereas two to three times this number will be reasonable to determine the elementary electronic charge.

Set-up:

Depending on the test method employed, use one stop-clock 1 or two stop-clocks 1 and 2 (see Fig. 3.1 – 3.3).

Switch on power supply by toggle switch at the instrument rear, set micrometer eyepiece in vertical position and adjust a sharp image by turning the black eyepiece ring.

Carrying out the experiment:

Atomize oil into the Millikan apparatus by strongly pressing the rubber ball and perform experiment according to 4.5.1 or 4.5.2.

4.5.1 Measuring method using one stop-clock (connected to socket pair ⑩)

Values to be measured:

Voltage U where a charged oil droplet is held stationary in the electric field of the plate capacitor.

Time t which, upon switching off the voltage, the same droplet requires to fall over a distance s' (to calculate the velocity of fall v_1 in the field-free space).

Measuring procedure:

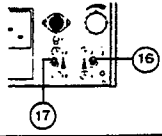
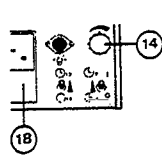
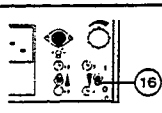
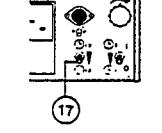
1.	Turn switches ⑰ and ⑱ to up position: the stop-clock is ready for measurement, and connection to the power supply of the capacitor is established.	
2.	Set voltage U on rotary knob ⑭ so that one droplet is held stationary in the lower third of the observation field (preferably on 1 scale division of the micrometer eyepiece). Read off voltage U .	
3.	Turn switch ⑱ to position 0: The voltage U is switched off, at the same time the stop-clock is started.	
4.	Observe the droplet falling in the field-free space, which rises in the microscopic image, and stop the clock by reversing switch ⑰ when the droplet has covered a distance s' of e. g. 30 μm .	

4.5.2 Measuring method using two stop-clocks (connected to socket pairs ⑩ and ⑫)

Values to be measured:

Time t_2 required by a droplet to rise over a distance s' when a voltage U is applied to the plate capacitor (to determine the rise velocity v_2 in the electric field).

Capacitor voltage U .

Time t_1 required by the same droplet to fall through a distance s' upon switching off the voltage (to determine the velocity of fall v_1 in the field-free space).

Measuring procedure:

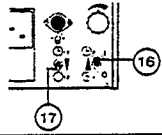
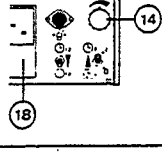
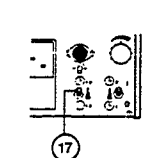
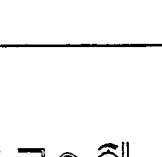
1.	Turn switch ⑰ down and switch ⑱ up: The control circuit for the stop-clocks is open, connection to the voltage supply of the capacitor is established.	
2.	Set a voltage U of 500 to 600 V on rotary knob ⑭ so that the oil droplets in the electric field slowly rise (observed as falling drops in the microscopic image); measure voltage U .	
3.	Select a slowly falling droplet in the upper third of the viewing field and reverse switch ⑰ exactly at the moment when this droplet passes a measuring mark (e. g. scale division 40 of micrometer scale): stop-clock 2 is started to measure the rate of rise t_2 in the electric field.	
4.	Observe the falling but actually rising droplet on the microscopic image and turn switch ⑱ to position 0 exactly at the moment when the droplet passes a second measuring mark (e. g. scale division 70 of the micrometer scale): the capacitor voltage U is switched off; at the same time stop-clock 2 stops and stop-clock 1 starts.	

5. Observe the droplet falling through the field-free space but rising in the microscopic image and reserve switch ⑰ exactly at the moment when the droplet passes the first measuring mark (e. g. 40) again: stop-clock 1 is stopped. When using the electric stop-clock P (313 03) or the counter P (575 45) — see Fig. 3.2/3 — stop time measurement on instrument 1 via switch (a) (stop it not possible via switch ⑰).

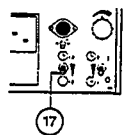

Notes:

When selecting a suitable droplet and, if necessary, during longer observation, the sharpness of the microscopic image can be readjusted using knurled knob ②. Generally, the sharpness need not be readjusted during measurement provided there is no draft in the room in which the apparatus is operated. A suitable droplet moving too far away from the ocular scale can easily be brought into the middle of the image by slightly turning the microscope.

Before starting a longer series of measurements, it is advisable to calculate at first the charges of two to three droplets to guide the experimenter in selecting a suitable droplet. It has shown that the charge of rapidly moving droplets is so high that information on the quantization and particularly on the magnitude of the greatest common divisor, viz. the elementary electronic charge e , is difficult to obtain. Droplets suitable in this sense were found to be such having approx. five elementary electronic charges max., i. e. useful results should be $< 10 \times 10^{-19}$ As.

Evaluation of measuring results:

After determining the velocity of the droplets, calculate the charge $Q = n \cdot e$ using equation (IV) or (V), depending on the measuring method employed (see Section 3).

When representing the measuring results in form of a histogram (see e. g. Fig. 4), the quantized structure of the electric charge becomes already clearly visible.

The elementary electronic charge e is obtained by forming the largest common divisor from the different charge values.

When comparing the resultant mean value for e with the precise value of the elementary electronic charge $e = 1.6 \times 10^{-19}$ As it is found that the empirical value of e is by approx. a factor

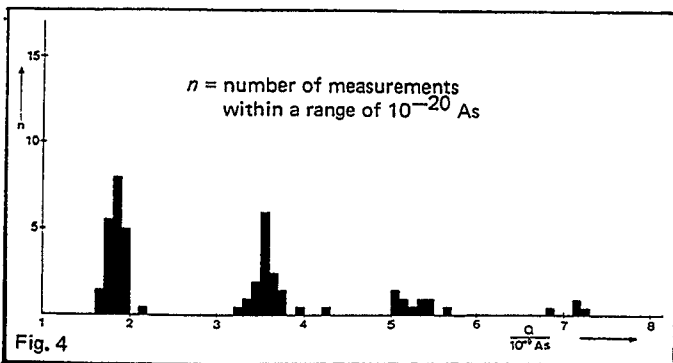

Fig. 4

1.1 too large. More exact investigations show that this factor increases as the radius of the observed oil droplet decreases. This phenomenon is due to the fact that Stoke's law on which the measurements are based no longer precisely applies to the size of the droplets used in this experiment which is between approx. 10^{-6} and 10^{-7} m and thus in the order of magnitude of the mean free path of the air molecules.

Correction of the empirical values for e

If the accuracy of the measured values should not meet the requirements, a corrective calculation as already used by Millikan can be applied here.

When designating the corrected charge as Q_c and the air pressure as p , measured in mbar, the following equation applies:

$$Q_c = \frac{Q}{\left(1 + \frac{b}{rp}\right)^{3/2}} \text{ or } Q^{2/3} = Q_c^{2/3} \left(1 + \frac{b}{rp}\right).$$

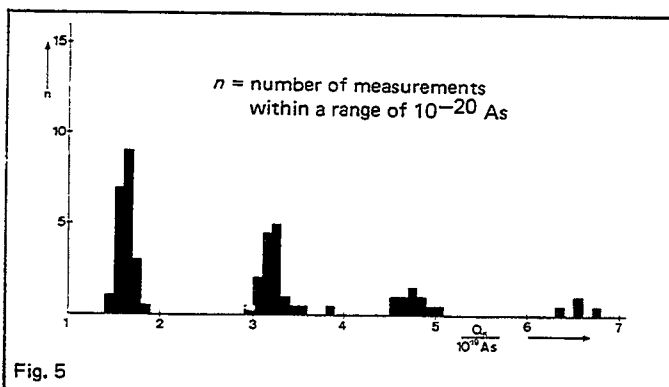

Fig. 5

b is a constant which can be graphically determined by an equation which is the equation of a straight line in the form

$$y = y_0 (1 + b x).$$

When plotting a graph of $y = Q^{2/3}$ as a function of $x = \frac{1}{rp}$ a straight line is obtained intersecting the ordinate at position $y_0 = Q_c^{2/3}$. When dividing the slope $\frac{dy}{dx}$ of the straight line by $y_0 = Q_c^{2/3}$, the constant b is obtained. For the here described measuring results $b = 6.33 \cdot 10^{-5}$ mbar \cdot m was obtained.

To enable the constant b to be determined with some accuracy, a much greater number of measurements as indicated above will be required. But as the size of the droplets used in our experiment is mostly in the order of 10^{-6} m, the above mentioned value for b can be used with satisfactory accuracy.

The corrective calculation for the measuring results shown in Fig. 4 gives the histogram with corrected charges as shown in Fig. 5.

When finally forming the mean from the 148 corrected elementary electronic charges contained in the results of these 85 measurements one obtains $e_c = 1.61 \cdot 10^{-19}$ As which differs only slightly from the precise value for the elementary electronic charge.

5 Changing to other mains voltages; Replacing a defective fuse

The power supply is set for connection to 220 V mains supply. This setting can be changed to 110 V, 130 V or 240 V by opening the cabinet and changing the transformer feed line.

For setting the other voltages proceed as follows:

Pull mains plug.

Remove one side panel after undoing the three fastening screws, withdraw bottom plate with transformer and put them on a table.

Pull off the spring terminal of the 220 V contact stud on the transformer and plug it onto the contact stud marked with the appropriate voltage.

In addition, when setting to 110 V a. c. or 130 V a. c., replace the fuse M 0.315 B by a fuse M 0.63 B.

When replacing a defective fuse, unscrew the fuse holder from the instrument panel with mains plug pulled.

6 Maintenance

Only small amounts of oil get into the Millikan apparatus by the oil atomizer. Therefore, chamber and acrylic glass cover need only be cleaned at large intervals using a soft, absorbent cloth.

The two boreholes in the acrylic glass cover through which the oil droplets are sprayed may become clogged with oil from time to time so that no droplets can enter the chamber. This can be remedied by piercing the borehole using a paper clip.

The atomizer only works satisfactorily when the rubber ball is in perfect condition. If the functioning of the apparatus is impaired by the unavoidable wear of the rubber, the rubber ball must be replaced (Spare Part No. 68 576).

7 Complement to section 4.3

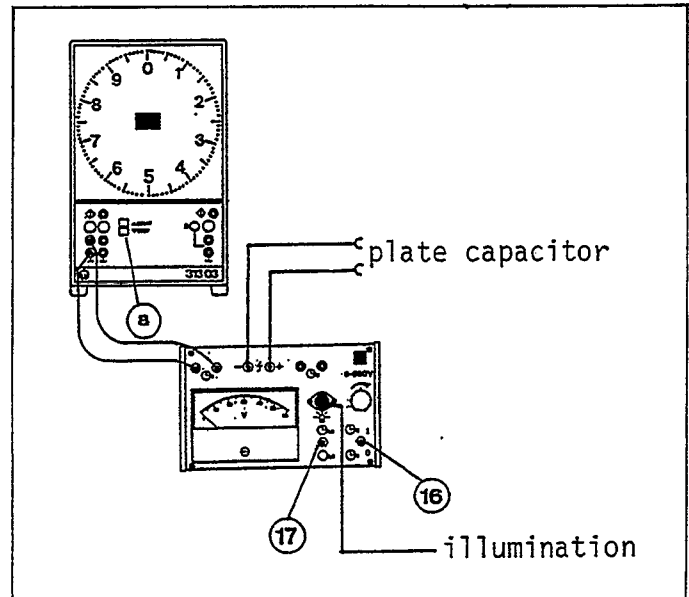

Fig. 6.1
Circuit with electronic stop-clock P for equilibrium method

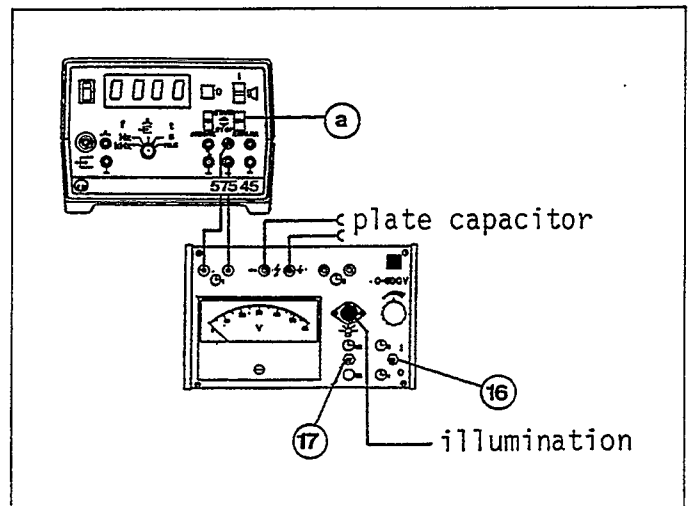

Fig. 6.2
Circuit with counter P for the equilibrium method

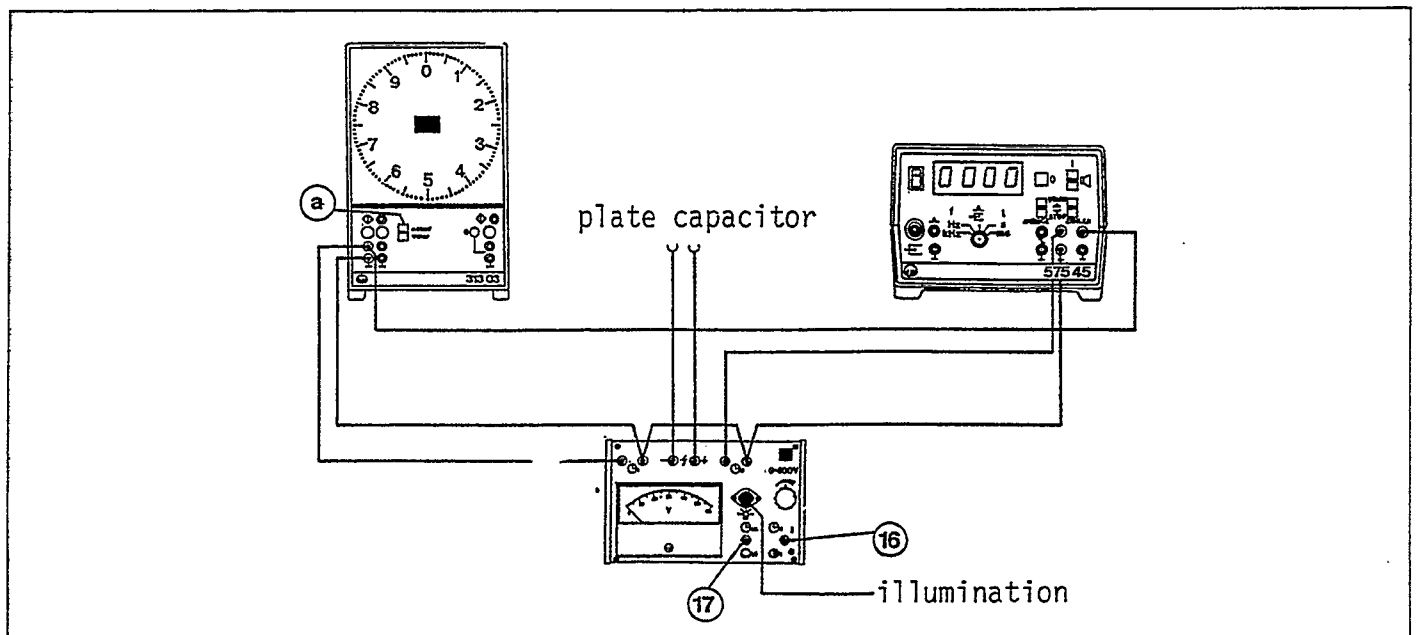

Fig. 6.3
Circuit with electronic stop-clock P and counter P for the dynamic method